



a⁺- and X-Series Label Printers

Made in Germany

CONTENTS

Overview types of industrial printers A+ series	4 - 5
For special demands	6 - 7
For textile materials.	8 - 9
The special ones for two-color printing	10 - 11
Technical data	12 - 13
Accessories - overview	14
Accessories - special equipment, interfaces, connecting cables	15
Accessories - cutting, perforating, stacking labels	16
Accessories - rewinding, unwinding labels	17
Accessories - dispensing labels	18 - 19
Applicator A1000.	20
Accessories - Applicator A1000.	21
Applicator A3200.	22
Accessories - mounting equipment	23
Label software cablabel S3	24
Integration	25
Stand-alone operation	26
Easy maintenance	26
Service, training	27
Delivery program for label printers	28
Delivery program for accessories	29 - 30
cab delivery program	31

*For current data
please refer to our website
www.cab.de/labelprinter*



*Scan the QR-Code
with your smartphone to get more
information about cab label printers*

Printers for industrial demands



Our professional printers are used in a wide variety of applications. During development, we focused first and foremost on simple and convenient operation coupled with high reliability. The printing units and housings are made of high-quality materials and are perfectly matched in terms of their form and function. Extensive peripherals and software enable customized solutions – any time.

Regardless of whether the A+ printer is operated as a stand-alone solution, a PC application or in a network, it is always up to the mark! The high-speed processor ensures fast job processing and immediate label output.

Accurate and fast output of small and large labels

PCB label

Smallest label size measuring 4 x 4 mm, if there is only little space available.



Nameplates

Sharp fonts, graphics and barcodes with 600 dpi.



Shipping and pallet labels

Labels up to standard A4 format.



Overview types of industrial printers A+ series



The Sleek

For small labels with high printing accuracy.

1.1	Label printer	A2+	
	Print resolution dpi	300	600
	Print width up to mm	54,2	57
	Print speed up to mm/s	150	100



The Universal

Our top-seller with high printing accuracy and an extensive range of accessories.

A4.3+ preferably for thermal direct printing.

1.2	Label printer	A4+			A4.3+	
	Print resolution dpi	203	300	600	203	300
	Print width up to mm	104	105,6	105,6	104	108,4
	Print speed up to mm/s	250	250	100	200	150



The Wide

Ideal for Odette- and UCC labels.

1.3	Label printer	A6+	
	Print resolution dpi	203	300
	Print width up to mm	168	162,6
	Print speed up to mm/s	200	200



The Extra Wide

For pallet and drum labeling.

1.4	Label printer	A8+
	Print resolution dpi	300
	Print width up to mm	216
	Print speed up to mm/s	150



Basic version

For printing on labels and continuous material. The material is torn off at the jagged tear-off edge. Optionally, it may be cut off or rewound externally.



Dispensing version

For printing and dispensing labels. The label is removed from the liner during the printing process by utilizing the internal rewinder. It can be removed manually, by applicator or robot.

Common details

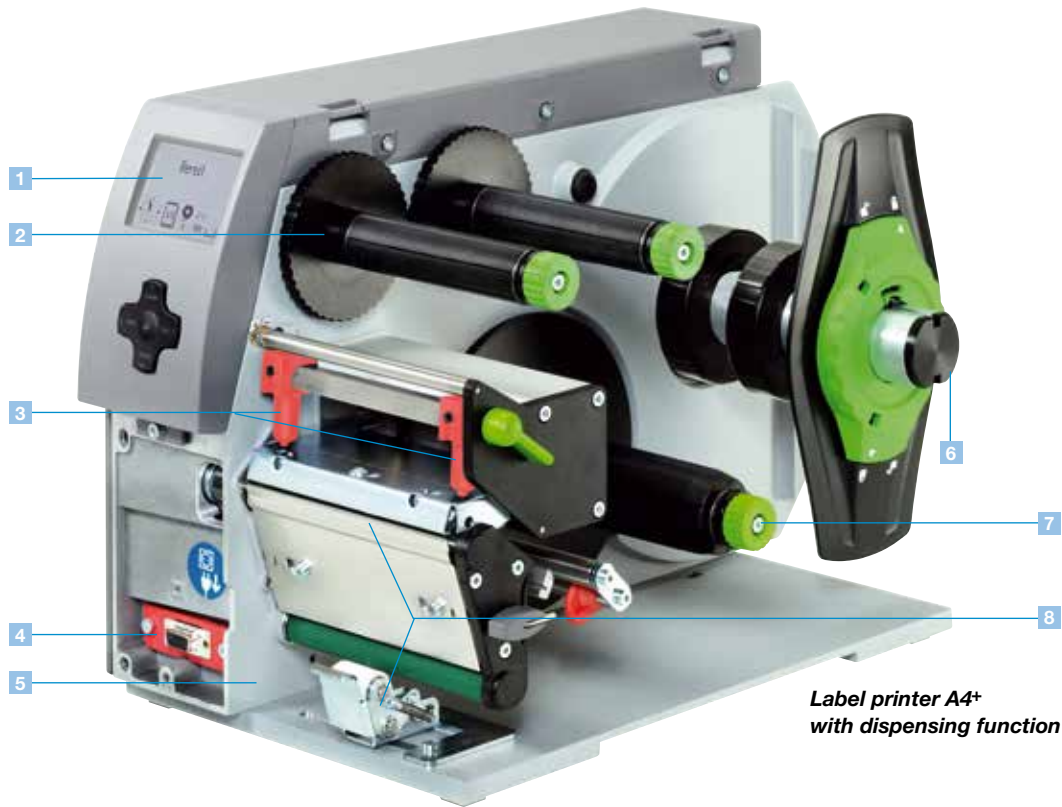

Label printer A4+ with dispensing function

- 1 White graphic display**
With backlight for optimum readability.
- 2 Ribbon holder**
Three-part tightening axles enable quick and easy ribbon exchange.
- 3 Straightforward adjustment**
The printhead is pressed down with two sliding toggles. One is mounted to the left label margin, the other is pushed to the right label margin.
- 4 Peripheral connection**
Add-on modules such as cutters, external rewinders, present sensors and applicators are easy to connect via the USB peripheral interface. All peripherals are connected to the printer in seconds using two pins and fixed in place with a screw.

- 5 Solid metal housing**
Made of die-cast aluminum. All components are mounted on it.
- 6 Roll holder**
Available for core diameters from 38 mm. (We provide adapters for core diameters wider than 76 mm for improved label winding). The spring-mounted margin stop ensures constant tension during feeding, thus ensuring a highly precise imprint.
- 7 Internal rewriter**
The three-part tightening axles ensure the easy rewinding and removing of labels or liners with or without paper core.
- 8 Peel-off option**
The label is removed from its liner via a peel-off plate. A high printing and dispensing accuracy can be achieved with the additionally powered rewind assist roller and the pinch roller.

Compact cover



The 2-part cover made of impact-resistant ABS plastic folds up when opened.

1.11 Metal cover



On request, the A4+ and A6+ transfer printers are also available with a metal cover. (as standard for the A8+).

For special demands



With centered material guide

Preferred for small and thick endless materials like flattened tubes, tapes or very small labels.

- No adjustment of the printhead for different widths of material
- Printing on very small or very thick continuous materials
- Print speed for difficult to print materials is reducible
- Operation and control are compatible with the A+ series

1.5	Label printer	A4+M	
	Print resolution dpi	300	600
	Print width up to mm	105,6	105,6
	Print speed up to mm/s	125	100



For double-sided printing

For simultaneous front and back printing via two stacked printing units. Preferred for flattened tubes, continuous or prefabricated, and paper, synthetic or cardboard materials.

- No adjustment of the printhead for different widths of material
- Printing on very small or very thick continuous materials
- Print speed for difficult to print materials is reducible
- Operation and control are compatible with the A+ series

1.6	Label printer	XD4
	Print resolution dpi	300
	Print width up to mm	105,6
	Print speed up to mm/s	125

Accessories



Cutter

Used to cut paper, self-adhesive labels, cardboard, textile or synthetic materials and heat shrink tubes.

Perforation and cutter

Used to enable the perforation of the material for manual separation.



Stacker with cutter

The printed materials are cut and stacked. The print job is stopped as soon as the maximum stack height is reached. Even stiff or curved materials may be processed to some extent. We recommend to do the material testings at our facilities.

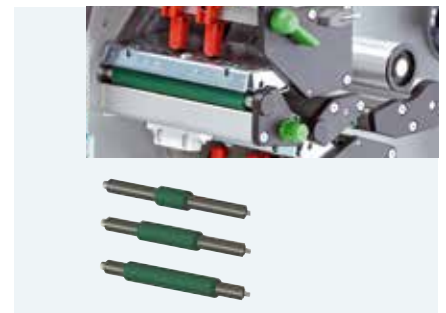

Print rollers for small and thin materials

Outside the material width the printhead rubs against the print rollers. The small print rollers are used to avoid feeding errors and wear on printhead and print roller due to rubbing. Three different standard widths are available from stock, non-standard widths are manufactured to order.

Common details

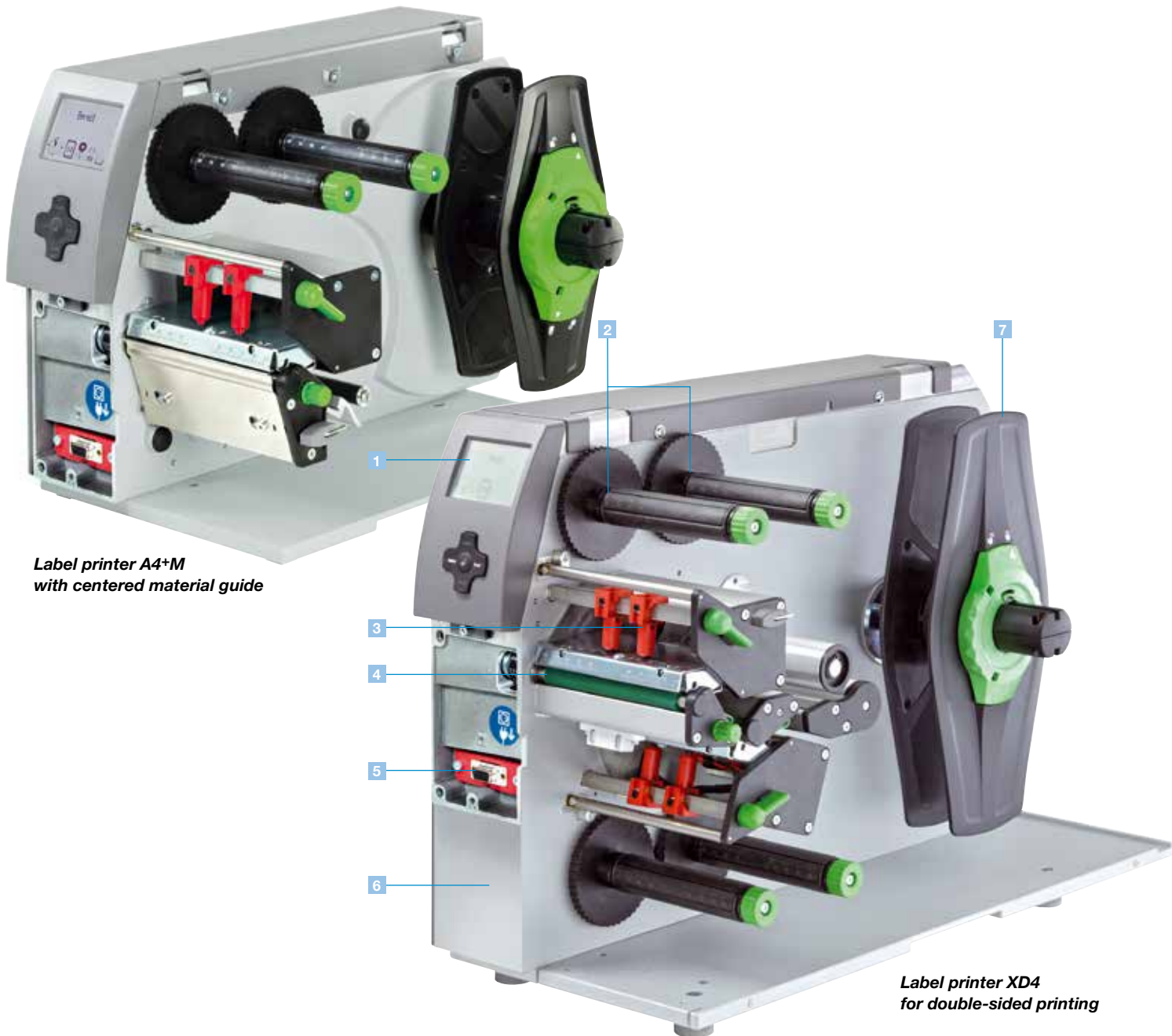

Label printer A4+M
with centered material guide

Label printer XD4
for double-sided printing

1 Big graphic display

White backlight for optimum readability.

2 Ribbon holder

Simple and centered insertion of the ribbon with the three-part tightening axes. The imprinted rule on spindle simplifies ribbon positioning.

3 No printhead adjustment

The printhead is pressed down with two sliding toggles. Due to the centre alignment of the materials there is no need to do adjustments and settings at the printhead.

4 Material guide

Precise printing as the material guide is located directly behind the print roller. The width is automatically adjusted and centered with a single knob.

5 Peripheral connection

Add-on modules such as cutter, perforation cutter and stacker are easy to connect.

6 Solid metal housing

Made of die-cast aluminum. All components are mounted on it.

7 Roll holder

Available for core diameters from 38 mm. (We provide adapters for core diameters wider than 76 mm for improved label winding). The material is automatically centered. The spring-mounted margin stop ensures constant tension during feeding, thus ensuring a highly precise imprint.

For textile materials



Single-sided printing

Particularly suitable for textile materials. The additionally installed drive roller after the printhead enables the textile material to be reliably separated from the transfer ribbon.

- No adjustment of the printhead for different widths of material
- Print speed for difficult to print materials is reducible
- Operation and control are compatible with the A+ series

1.7	Label printer	A4+T
	Print resolution dpi	300
	Print width up to mm	105,6
	Print speed up to mm/s	125



For double-sided printing

For simultaneous front and rear printing of textile materials. The additionally installed drive roller after the printhead enables the textile material to be reliably separated from the transfer ribbon.

- No adjustment of the printhead for different widths of material
- Print speed for difficult to print materials is reducible
- Operation and control are compatible with the A+ series

1.8	Label printer	XD4T
	Print resolution dpi	300
	Print width up to mm	105,6
	Print speed up to mm/s	125

We are glad to assist you in the optimum selection of transfer ribbons for the label material.

Accessories



Cutter

Used to cut paper, self-adhesive labels, cardboard, textile or synthetic materials and heat shrink tubes.

Perforation and cutter

Used to enable the perforation of the material for manual separation.



Stacker with cutter

The printed materials are cut and stacked. The print job is stopped as soon as the maximum stack height is reached. Even stiff or curved materials may be processed to some extent. We are pleased to do the material testings at our facilities.

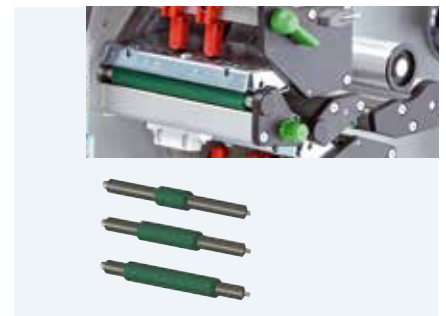

Print rollers for small and thin materials

Outside the material width the printhead rubs against the print rollers. The small print rollers are used to avoid feeding errors and wear on print head and print roller due to rubbing. Three different standard widths are available from stock, non-standard widths are manufactured to order.

Common details

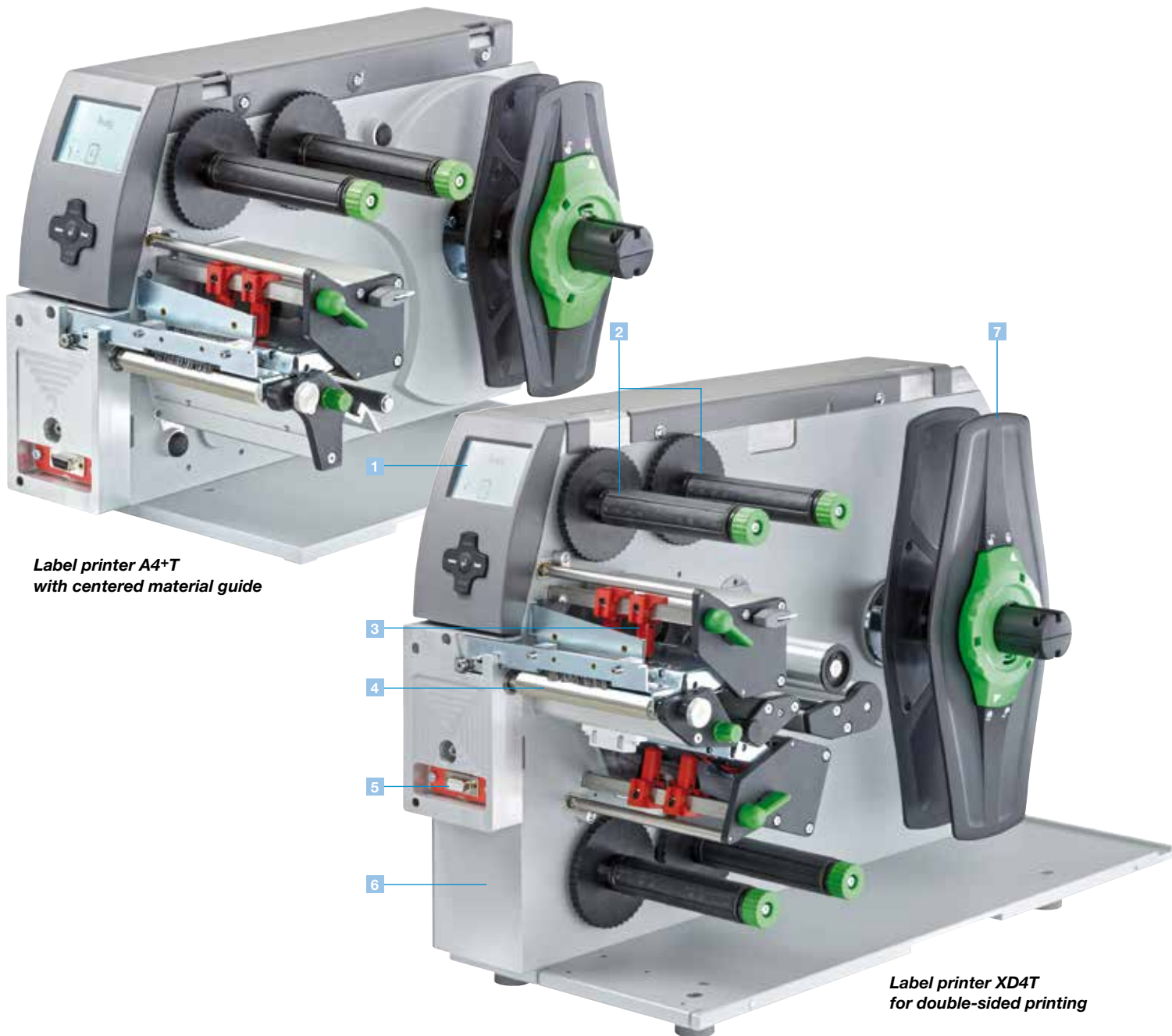

Label printer A4+T
with centered material guide

Label printer XD4T
for double-sided printing

1 Big graphic display

White backlight for optimum readability.

2 Ribbon holder

Simple and centered insertion of the ribbon with the three-part tightening axes. The imprinted rule on spindle simplifies ribbon positioning.

3 No printhead adjustment

The printhead is pressed down with two sliding toggles. Due to the centre alignment of the materials there is no need to do adjustments and settings at the printhead.

4 Separator roller

The additionally installed separator roller enables the textile material to be reliably separated from the transfer ribbon.

5 Peripheral connection

Add-on modules such as cutter, perforation cutter and stacker are easy to connect.

6 Solid metal housing

Made of die-cast aluminum. All components are mounted on it.

7 Roll holder

Available for core diameters from 38 mm. (We provide adapters for core diameters wider than 76 mm for improved label winding). The material is automatically centered. The spring-mounted margin stop ensures constant tension during feeding, thus ensuring a highly precise imprint.

The special ones for two-color printing



For two-color printing

- Two in-line arranged thermal transfer print units for simultaneous two-color printing in one label
- Ribbon saver at one print unit
- The XC-series meets the conditions for the Classification and Labeling Inventory according to GHS
- For large label rolls up to a diameter of 300 mm
- The two print units with ribbon holder, operation panel and electronics are adopted from the proven A+ series

1.9	Label printer	XC4
	Print resolution dpi	300
	Print width up to mm	105,6
	Print speed up to mm/s	125



1.10	Label printer	XC6
	Print resolution dpi	300
	Print width up to mm	162,6
	Print speed up to mm/s	125

We are glad to assist you in the optimum selection of transfer ribbons for the label material.

Accessories



Cutter

Used to cut paper, self-adhesive labels, cardboard, textile or synthetic materials and heat shrink tubes.

Perforation and cutter

(only for XC4). Used to enable the perforation of the material for manual separation.



Stacker with cutter

(only for XC4). The printed materials are cut and stacked. The print job is stopped as soon as the maximum stack height is reached. Even stiff or curved materials may be processed to some extent. We recommend to do the material testings at our facilities.

Common details



1 Big graphic display

White backlight for optimum readability.

2 Ribbon holder

Simple and centered insertion of the ribbon with the three-part tightening axles. The imprinted rule on spindle simplifies ribbon positioning.

3 Straightforward adjustment

The printhead is pressed down with sliding toggles. One is mounted to the left label margin, the other is pushed to the right label margin.

4 Peripheral connection

Add-on modules are easy to connect. All peripherals are connected to the printer in seconds using two pins and fixed in place with a screw.

5 Solid metal housing

Made of die-cast aluminum. All components are mounted on it.

6 Roll holder

For labels up to a diameter of 300 mm. Swing lever and integrated brake make sure that the labels are unwound with constant tension.

7 Ribbon saver for printhead 1

The ribbon saver is used for labels to be partially printed. The printhead is lifted within the unprinted area and the ribbon stopped during label feeding.

8 Fanfold guide

Fanfolded labels are positioned behind the print unit. Guide and additional brake ensure a reliable feeding to the print unit.

Technical data

■ Standard □ Option

	1.1	1.2	1.3	1.4	1.5	1.6	1.7	1.8	1.9	1.10						
Label printer	A2+	A4+	A6+	A8+	A4+M	XD4	A4+T	XD4T	XC4	XC6						
Print head																
Print method	Thermal transfer ■ ■ ■ ■ ■ ■ ■ ■ ■ ■ ■ ■ ■ ■ ■ ■															
	Thermal direct ■ – ■ ■ – ■ ■ ■ ■ ■ ■ ■ ■ ■ ■ ■ ■ ■ ■ ■ ■															
Print resolution dpi	300	600	203	300	600	203	300	300	300	300	300	300	300	300	300	300
Print speed up to mm/s	150	100	250	250	100	200	200	150	125	100	125	125	125	125	125	125
Print width mm	54,2	57	104	105,6	105,6	168	162,6	216	105,6	105,6	105,6	105,6	105,6	105,6	162,6	162,6
Material																
Labels or fanfolded	Paper, cardboard, textile, plastics such as PET, PE, PP, PI, PVC, PU, acrylate															
Continuous rolls	Paper, cardboard, textile, plastics such as PET, PE, PP, PI, PVC, PU, acrylate															
Material thickness mm / weight g / m ²	0,05 - 0,8 / 60 - 300															
Width labels ¹⁾ mm	4 - 63	20 - 116			46 - 176		46-220	4 - 106	–	4 - 106	–	20-116	46-176			
continuous material / liner mm	24 - 67	24 - 120			50 - 180		50-235	10 - 110			24-120		50-180			
continuous material mm	24 - 67	24 - 120			50 - 180		50-235	10 - 110			–		–			
continuous shrink tube mm	10 - 67	25 - 85			–		–	4 - 85	4 - 85	–		–				
Height ¹⁾ without back-feed from mm	4	4	4	4	4	6	6	10	5	5	20	5	20	20		
when dispensing ¹⁾ from mm	12	12	12	12	12	25	25	–	–	–	–	–	–	–		
up to mm	5000	2000	5000	4000	1000	4000	3000	2000	4000	1000	2000	4000	2000	2000	1500	
Media roll Outside diameter up to mm	205			205			205	300	205	300	300	300				
Core diameter mm	38 - 100										76					
Winding	Outside or inside															
Ribbon																
Ink	Outside or inside															
Roll diameter up to mm	80			72		80	72	80	72	80	72	72				
Core diameter mm	25			25		25	25	25	25	25	25	25				
Ribbon length variable up to m	500			360		500	360	500	360	500	360	360				
Width ²⁾ up to mm	57	114			165		220	114	114	114	114	114	114	165		
Internal rewinder (only for peel-off version)																
Outside diameter up to mm	142			–		–		–		–		–				
Core diameter mm	38,1			–		–		–		–		–				
Winding	Only outside			–		–		–		–		–				
Dimensions Printer																
Height mm	274					395		274	395	395						
Depth mm	446					554		446	554	554						
Width mm	190	242			302	352	242	248	242	248	248	358				
Weight kg	8,5	9			13	15	9	21	9	21	22	24				
Label sensor																
Gap sensor	For leading edge or punch marks and end of material															
Reflective sensor from the bottom / optional from the top	For print marks															
Distance to locating edge mm	5 - 26	5 - 53			5 - 53		–	–	–	5 - 53						
Distance from center to the left mm	–	–			–		0 - 53		–							
Electronics																
Processor 32 Bit clock rate MHz	266															
RAM MB	64															
Memory IFFS MB Flash	8															
Slot for CompactFlash Type I memory card	■															
Slot for Wireless LAN card	■															
Battery buffer for real-time clock, printout of time and date, data storage on shut-down	■															
Warning signal: acoustic signal in case of error	■															
Interfaces																
Centronics bi-directional acc. to IEEE 1284	□							–								
RS232 C 1.200 up to 230.400 Baud / 8 Bit	■							–								
USB 2.0 High Speed Slave for PC connection	■							■								
Ethernet 10 / 100 Base T, LPD, RawIP-printing, ftp printing, DHCP, HTTP, FTP, SMTP, SNMP, TIME, Zeroconf, mDNS, SOAP	■							■								
RS422, RS485 1.200 up to 230.400 Baud / 8 Bit	□							–								
Peripheral connection	■							■								
WLAN Card 802.11b/g WEP/WPA PSK (TKIP)	□							□								
2 x USB master for external operation panel, keyboard, scanner, service key, USB flash drive	■							■								
Operating data																
Power supply	100 - 240 V ~ 50 / 60 Hz, PFC															
Power consumption	100 - 300 W depending on type of printer															
Temperature / humidity	Operation: + 5 - 40°C / 10 - 85% not condensing															
	Stock: + 0 - 60°C / 20 - 80% not condensing															
	Transport: – 25 - 60°C / 20 - 80% not condensing															
Approvals	CE, FCC class A, CB, CCC, UL															

¹⁾ Limitations may apply to small labels, thin materials or strong adhesives. These applications need to be tested and approved.

²⁾ The ribbon should roughly be the same width as the label in order to avoid folding.

Operation panel	
Buttons/LED display	Pause, Feed, Cancel, Menu, Enter, 4 x Cursor
LCD graphic display	Width 60, Height 40 mm, Text 4 lines, approx. 20 characters per line
Settings	
Digital or analog clock	Time
System settings	Date
Print parameters	Interfaces
25 language settings	Security
On the Display	
Data reception	Clock
WLAN field intensity	Date sheet
Ethernet status	abc Debug
Used memory	Input buffer
Temperature printhead	Remaining ribbon
Access to memory card	
Monitoring	
Stop printing if	End of ribbon End of labels Printhead open Final position not reached
Test routines	
System diagnosis	When switched on, including printhead testing
Short status, status print	Font list, device list, WLAN Status, label profile, test grid, monitor mode, PPP status
Status reports	Status printout with information about settings, e.g. print length counter, runtime counter, etc. Request of status via software command. Status messages on the display, e.g. network error - no link, barcode error, etc.
Fonts	
Font types	5 Bitmap fonts, incl. OCR-A, OCR-B and 3 Vector Fonts Swiss 721, Swiss 721 Bold and Monospace 821 internally available, loadable TrueType fonts. Thai and Chinese (simplified Chinese) available as option.
Character sets	Windows 1250 up to 1257, DOS 437, 737, 775, 850, 852, 857, 862, 864, 866, 869, EBC DIC 500, ISO 8859-1 up to -10 and -13 up to -16, WinOEM 720, UTF-8, Macintosh Roman, DEC MCS, KOI8-R. All West and East European Latin, Cyrillic, Greek, Hebrew and Arabic characters are supported. Thai and Chinese available as option.
Bitmap fonts	Size of width and height 1 – 3 mm Zoom 2 – 10 Orientation 0°, 90°, 180°, 270°
Vector- / TrueType fonts	Size of width and height 0,9 – 128 mm Variable zoom, Orientation 360° in steps of 1°
Font formats	Bold, Italic, underlined, outline, inverse, depending on character fonts
Font width	Variable

















Graphics			
Graphic elements	Line, arrow, box, circle, ellipse, filled and filled with fading		
Graphic formats	PCX, IMG, BMP, TIF, MAC, GIF, PNG		
Barcodes			
Linear barcodes	Code 39, Code 93 Code 39 Full ASCII Code 128 A, B, C EAN 8, 13 EAN / UCC 128 EAN / UPC Appendix 2 EAN / UPC Appendix 5 FIM HIBC	Interleaved 2 / 5 Ident- and lead code of Deutsche Post AG Codabar JAN 8, 13 MSI Plessey Postnet RSS 14 UPC A, E, E0	
2D codes	Aztec, Codablock F, Data Matrix, PDF 417, Micro PDF 417, UPS Maxicode, QR-Code, RSS 14 truncated, limited, stacked and stacked omnidirectional, EAN-Datamatrix, GS1 Data Bar All codes are variable in height, module width and ratio. Orientation 0°, 90°, 180°, 270°. Optionally with check digit, printed characters and start/stop code depending on type of code.		
Software			
Programming	J-Script direct programming abc-Basic Compiler Database Connector	■ ■ ■	
System diagnosis/administration	Printer monitoring Administration Network Manager	■ ■	
Label software	cablabel® S3 Lite cablabel® S3 Viewer cablabel® S3 Pro	■ ■ □	
Windows driver certified	32 / 64 bit für Windows XP Windows Vista Windows 7 Windows 8 Windows 8.1	Server 2003 Server 2008 Server 2008 R2 Server 2012 Server 2012 R2	■
Mac- driver*	OS X printer driver from version 10.6	■	
Linux driver*	32/64 Bit from CUPS 1.2	■	
Stand-alone-operation		■	
*only A+ series			

Accessories - overview

● Typical ○ Possible ■ Standard □ Option

			1.1	1.2	1.3	1.4	1.5	1.6	1.7	1.8	1.9	1.10
Extras			A2+	A4+	A6+	A8+	A4+M	XD4	A4+T	XD4T	XC4	XC6
	Basic device	Dis-pensing										
2.1	Metal cover	●	●	□	□	■	□	■	-	■	■	■
2.2	Print roller DR4M-25, 50, 80	●	-	-	-	-	□	□	□	□	-	-
2.3	Reflective label sensor from the top	●	●	□	□	□	-	-	-	-	-	-
2.4	Adapter 100 mm Ø	●	●	□	□	□	□	□	□	□	-	-
2.5	Memory card	●	●	□	□	□	□	□	□	□	□	□
2.6	Standard keyboard USB	●	●	□	□	□	□	□	□	□	□	□
2.7	External operation panel	●	●	□	□	□	□	□	□	□	□	□
2.8	Pause adapter PS7 - interrupt print job	●	○	□	□	□	□	-	-	-	-	-
2.9	Tester CC for linear and 2D barcodes	●	●	□	□	□	-	-	-	-	-	-
Interfaces												
3.1	Centronics Interface	●	●	□	□	□	□	-	□	-	-	-
3.2	RS422 / RS485 Interface	●	●	□	□	□	□	-	□	-	-	-
3.3	Label selection – I/O box	●	●	□	□	□	□	□	□	□	□	□
3.4	WLAN card 802.11 b/g	●	●	□	□	□	□	□	□	□	□	□
Connecting cable												
4.1	Cable RS232 C, 9/9-pin, length 3 m	●	●	□	□	□	□	□	□	□	□	□
4.2	Patch cable CAT 5e, length 3 m, gray	●	●	□	□	□	□	□	□	□	□	□
Cutting, perforating, stacking labels												
5.1	Cutter CU	●	○	□	□	□	□	□	□	□	□	□
5.2	Cutter tray	●	○	-	□	-	-	□	-	-	-	-
5.3	Perforation cutter PCU4	●	○	-	□	-	-	□	□	□	○	-
5.4	Stacker with cutter ST4 / L	●	○	-	□	-	-	-	-	-	□	-
5.4	Stacker with cutter ST4 / M	●	-	-	-	-	-	□	□	□	-	-
5.5	Base frame A4+	●	-	-	□	-	-	□	-	□	-	-
Rewinding, unwinding labels												
6.1	Rewind guide plate for internal rewinding	-	●	□	□	-	-	-	-	-	-	-
6.2	External rewinder for direct printer connection	●	○	□	□	□	□	-	-	-	-	-
6.3	External rewinder with built-in power supply	●	○	□	□	□	□	□	□	□	□	□
6.4	External rewinder for rolls up to 300 mm Ø	●	○	□	□	□	□	□	□	□	□	□
Dispensing labels												
7.1	Peel-off adapter on request	-	●	□	□	□	-	-	-	-	-	-
7.2	Extended peel-off plate	-	●	□	□	□	-	-	-	-	-	-
7.3	Present sensor PS6 for manual operation or on request	-	●	□	□	□	-	-	-	-	-	-
7.4	Present sensor PS8 for manual operation	-	●	□	□	□	-	-	-	-	-	-
7.5	Present sensor PS9 variable	-	●	□	□	-	-	-	-	-	-	-
For dispensing labels												
8.1	Manual switch TR1	-	●	□	□	□	-	-	-	-	-	-
8.2	Foot switch	-	●	□	□	□	-	-	-	-	-	-
8.3	Interface connector / 15-pin Sub-D plug	-	●	□	□	□	-	-	-	-	-	-
8.4	Product sensor	-	●	□	□	□	-	-	-	-	-	-
8.5	Testbox 2 / automatic operation	-	●	□	□	□	-	-	-	-	-	-
Applicators and Dispensing module												
9.1	Dispensing module A5100	-	●	-	□	□	-	-	-	-	-	-
9.2	All-round labeling	-	●	□	□	-	-	-	-	-	-	-
9.3	Applicator A1000	-	●	□	□	□	-	-	-	-	-	-
9.4	Tamp pad A1021 W x H	-	●	□	□	□	-	-	-	-	-	-
9.4	Universal tamp pad A1021 70 x 60	-	●	□	□	○	-	-	-	-	-	-
9.4	Universal tamp pad A1021 90 x 90	-	●	-	□	○	-	-	-	-	-	-
9.5	Tamp pad A1321 W x H	-	●	-	□	□	-	-	-	-	-	-
9.5	Universal tamp pad A1321 116 x 102	-	●	-	□	○	-	-	-	-	-	-
9.5	Universal tamp pad A1321 116 x 152	-	●	-	□	○	-	-	-	-	-	-
9.6	Blow pad A2021 W x H	-	●	□	□	□	-	-	-	-	-	-
9.7	Roll-on pad	-	●	-	□	□	-	-	-	-	-	-
9.8	Applicator A3200	-	●	□	□	-	-	-	-	-	-	-
9.9	Tamp pad A3221 W x H	-	●	□	□	-	-	-	-	-	-	-
9.10	Blow pad A3221 W x H	-	●	□	□	-	-	-	-	-	-	-
For dispensing labels and applicators												
10.1	Mounting plate	-	●	□	□	-	-	-	-	-	-	-
10.2	Profile 40 / 80 / 120 mm	-	●	□	□	-	-	-	-	-	-	-
10.3	Base plate 500 x 255	-	●	□	□	-	-	-	-	-	-	-
10.4	Floor stand 1600	-	●	□	□	□	-	-	-	-	-	-
10.5	Printer holder A2+ / A4+ / A6+	-	●	□	□	□	-	-	-	-	-	-
Software												
11.4	Database Connector	●	●	■	■	■	■	■	■	■	■	■
11.6	Administration Network Manager	●	●	■	■	■	■	■	■	■	■	■
11.7	Label software cablabel® S3 Lite	●	●	■	■	■	■	■	■	■	■	■
11.7	Label software cablabel® S3 Pro	●	●	□	□	□	□	□	□	□	□	□
11.10	Programmer's guide	●	●	□	□	□	□	□	□	□	□	□

Accessories-special equipment, interfaces, connecting cables

Extras	Product
2.1 	Metal cover On request, the label printers A4+ and A6+ are available with metal cover. (supplied with A8+ as standard).
2.2 	Print roller DR4-M25 For small and thin materials up to a width of 25 mm.
	Print roller DR4-M50 For very thin materials from a width of 20 up to 50 mm.
	Print roller DR4-M80 For very thin materials up to a width of 80 mm.
2.3 	Reflective label sensor from top
2.4 	Adapter 100 mm Ø To keep the bending to a minimum during stacking it is recommended to use a large core diameter.
2.5 	Memory Card CompactFlash Type I
2.6 	Standard keyboard USB Connection: USB, number of keys: 115
2.7 	External operation panel If the operation panel is not accessible, e.g. after installation within a facility, an external panel can be installed. Additional slots are available for a CF memory card Type 1 and a host interface.
2.8 	Pause adapter PS7 For printing in a label loop. The print job is stopped by the pause signal. The label being printed is finished first. I/O Interface: Inputs: Outputs: no print job Pause, external error printer not ready, print job active
2.9 	Tester CC for linear and 2D barcodes The camera tests readability or contents of the horizontally and vertically printed barcodes directly after printing. If the code is faulty the print job is stopped and the label is removed. The Tester CC can be used together with the tear-off mode, dispensing mode or with the external rewinder. Please refer to the Operation Manual for further details.
Interfaces	Product
3.1 	Centronics Interface bi-directional acc. to IEEE 1284
3.2 	Interface RS422/RS485 1.200 up to 230.400 Baud/8 Bit
3.3 	Label selection box – I/O box From a higher-level control, like a PLC, up to 16 different labels can be selected from the memory card. The I/O box enables via abc programming to realize easy programming of the PLC with the 4 in- and outputs.
3.4 	WLAN card 802.11 b/g
Connecting cable	
4.1 	Connecting cable RS232 C 9/9 pin, length 3 m
4.2 	Patch cable CAT5e , 3 m, gray

Accessories - cutting, perforating, stacking labels

5.1



Cutter CU

The cutter is used to cut paper, self-adhesive labels, cardboard, textiles or plastics and heat shrink tubes.

Cutter tray

Up to about 50 labels may be collected in the cutter tray.

Cutter	CU2	CU4	CU6	CU8	
Used for printer model	A2+	A4+	A4+M, A4+T XD4, XD4T, XC4	A6+ XC6	A8+
Material width up to mm	67	120	110	180	232
Material weight cardboard gr/m ²	60 - 500				
Material thickness mm	0,05 - 0,8				
Cutting length mm	> 5				
Gap height up to mm	2,5				
Cuts / min.	130	120	110	100	
Stop print job, if	Final position of cutter not reached				
Cutter tray 4 for A4+ / A4+ M					
Label height up to mm	100				

5.2

5.3



Perforation cutter and cutter PCU4

The perforation cutter enables additionally perforating the material for manual separation later on.

Perforation cutter and cutter	PCU4
Used for printer model	A4+, A4+M, A4+T, XD4, XD4T, XC4
Material width up to mm	85
Material weight cardboard gr/m ²	60 - 300
Material thickness mm	0,05 - 0,8
Cutting length mm	> 5
Gap height up to mm	4,5
Cuts / min.	Cutting 120 / Perforating 150
Stop print job, if	Final position of cutter not reached
Perforating: Web width mm	0,5
Web distances mm	2,5 or 10

5.4



Stacker with cutter ST4

The printed materials are cut and stacked. The print job is stopped as soon as the maximum pile height is reached. Even stiff or curved materials may be processed to some extent.

We recommend to do the material testings at our facilities.

Stacker with cutter	ST4 / L	ST4 / M
Used for printer model	A4+, XC4	A4+M, A4+T, XD4, XD4T
Material width up to mm	20 - 110	20 - 100
Material weight cardboard gr/m ²	60 - 300	
Material thickness mm	0,05 - 0,8	
Cutting length mm	20 - 150	
Gap height up to mm	1,2	
Cuts / min.	120	
Stop print job, if	Final position of cutter not reached, cover open, stack height reached	
Pile height up to mm	100	



Storage table label W x H

Storage table and protective cover are adapted to the label size and need to be ordered separately.

5.5

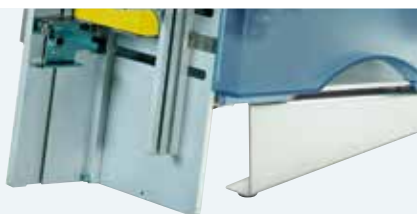

Base frame A4+

The base frame is used to place the devices on the table in any position.

Accessories - rewinding, unwinding labels



Rewind guide plate RG for internal rewinding

Internal rewinding is done by using the dispensing printer. In this case, the peel-off plate is replaced by the rewind guide plate.

Rewind guide plate	RG2	RG4
Application	A2+ dispensing version	A4+ dispensing version
Material width up to mm	67	120



External rewriter ER1/2/3 for direct printer connection

The rewriter is directly screwed onto the printer. Labels are optionally wound either inside or outside. Electronic control of the swing arm ensures a smooth and tight winding.

External rewriter	ER1 / 210	ER2 / 210	ER3 / 210
Application	A2+	A4+	A6+
Material width up to mm	67	120	180
Roll Ø max. mm	205	205	205
Core Ø mm	40 / 76		
Label winding	outside or inside		

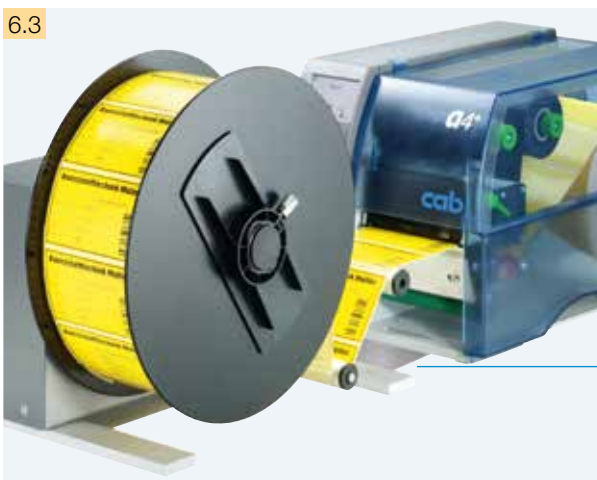

External rewriter ER4/6/8 with built-in power supply

The rewriter may be attached to any other printer. All other technical data comply with rewriter ER1/2/3.

External rewriter	ER4 / 210	ER4 / 300	ER6/300	ER8/300
Application	A2+ A4+, A4+M A4+T, XC4 XD4, XD4T	A2+ A4+, A4+M A4+T, XC4 XD4, XD4T	A6+, XC6	A8+
Material width up to mm	67	120	180	235
Roll Ø max. mm	205	205	300	300
Core Ø mm	40 / 76			
Label winding	outside or inside			
Operating voltage	100 – 240 V~ 50 / 60 Hz			
Connecting set for	ER / EU			
Adapter for XC4 / XC6	RG4	RG4	RG6	–



External unwinder EU4/6/8





The unwinder ensures a smooth label feed for heavy rolls. Both inside and outside wound rolls may be used.

External unwinder	EU4 / 300	EU6 / 300	EU8 / 300
Application	A2+ A4+, A4+M, A4+T	A6+	A8+
Material width up to mm	67	120	235
Roll Ø max. mm	300	300	300
Core Ø mm	40 / 76		
Label winding	outside or inside		

Accessories - dispensing labels







- 1 Label printers (Type „P“) for dispensing labels additionally need to have a present adapter or a present sensor. Different types for either manual operation, or on demand with hand switch, foot switch or an external signal are available.

Product											
7.1	 <p>Present adapter PS5 for automatic operation Printing and dispensing the label is triggered via external signal. The label is removed by an applicator or robot.</p> <p>I/O Interface:</p> <table border="0"> <tr> <td>Inputs:</td> <td>Outputs:</td> </tr> <tr> <td>Start</td> <td>No print job</td> </tr> <tr> <td>Label removed</td> <td>Printer not ready</td> </tr> <tr> <td>External error</td> <td>Print started</td> </tr> <tr> <td></td> <td>Label in dispensing position</td> </tr> </table>	Inputs:	Outputs:	Start	No print job	Label removed	Printer not ready	External error	Print started		Label in dispensing position
Inputs:	Outputs:										
Start	No print job										
Label removed	Printer not ready										
External error	Print started										
	Label in dispensing position										
7.2	 <p>Extended peel-off plate only in connection with present adapter PS5 or an applicator. For labels particularly difficult to remove from liner the peel-off plate with rewind guide plate, extended by 10 mm, is used.</p>										
7.3	 <p>Present sensor PS6 for manual other automatic operation</p> <p>1. For manual operation The present sensor detects the label being in dispensing position and interrupts the print job. As soon as the label has been manually removed the next one is printed immediately.</p> <p>2. Automatic operation Dispensing at automatic operation either via hand switch or foot switch, or via external signal according to PS5.</p> <p>I/O Interface:</p> <table border="0"> <tr> <td>Inputs:</td> <td>Outputs:</td> </tr> <tr> <td>Start</td> <td>No print job</td> </tr> <tr> <td>External error</td> <td>Printer not ready</td> </tr> <tr> <td></td> <td>Print started</td> </tr> <tr> <td></td> <td>Label in dispensing position</td> </tr> </table>	Inputs:	Outputs:	Start	No print job	External error	Printer not ready		Print started		Label in dispensing position
Inputs:	Outputs:										
Start	No print job										
External error	Printer not ready										
	Print started										
	Label in dispensing position										
7.4	 <p>Present sensor PS8 for manual operation The present sensor detects the label being in dispensing position and interrupts the print job. As soon as the label has been manually removed the next one is printed immediately.</p>										
7.5	 <p>Present sensor PS9 variable For dispensing odd shaped labels where the leading edge of the label is not on the left edge where the PS8 can detect it, ex. round labels. The extension is customized.</p>										

Accessories - dispensing labels

for Present adapter PS5
Present sensor PS6
Pause adapter PS7

Dispensing module 5100A
Applicator A1000
Applicator A3200

Product	
8.1	 <p>Hand switch TR1 Printing and dispensing on demand.</p>
8.2	 <p>Foot switch Printing and dispensing on demand.</p>
8.3	 <p>Sub D plug Sub D plug 15 pin with screw clamps for PS5, PS6, PS7 and Applicators. To connect external control signals.</p>
8.4	 <p>Product sensor For automatic product detection on the conveyor belt.</p>
8.5	 <p>Testbox 2 Simulation of automatic operation.</p>



Dispensing module with dispensing adapter PS5

To apply labels on packaging on a conveyor belt.
The product sensor triggers the printing process.
Labeling is started and at the same time the next label is printed.
Conveyor speed and print speed need to be synchronized.

	A5104	A5106
Application	A4+	A6+
Label width mm	25 - 116	50 - 176
Label height mm	25 - 200	
Product surface	flat	
Product height	fixed	
Product during labeling	in motion with synchronized speed to printer	



All-round print and apply system

Together with the A1000 applicator the all-round print and apply system enables to apply labels on cylindrical objects around the entire circumference of 360°. The product is put on the rolls and labeling is started via hand or foot switch.

All-round labeler	
Application	A2+, A4+ with applicator A1000-220
Product diameter mm	12 - 40
Product surface	cylindrical
Product during labeling	in rotary motion
Tamp pad	
Label width mm	25 - 116
Label height mm	25 - 140

Applicator A1000

9.3



Real-time application

Together with the A2+, A4+ and A6+ printers the A1000 applicator means a cost-effective solution for both semi-automatic operation and for integration into automated product lines. For operation compressed air of 4,5 bar is needed.

1 Long service life

The ball-bearing guide bars are low-wearing.

2 Variable product heights

The lifting cylinder allows labeling at different heights. Different stroke heights are available.

3 Pre-dispensing button

For testing the labeling. Pushing the button the first time causes the label to be printed and held by the pad. Pushing the button again starts the application.

4 Compressed air regulation unit

The microfilters prevent contamination, the compressed air regulator ensures the labeling quality.

5 High process reliability

The supporting air jet stream, induction air and lifting speed can be adjusted. The pressure can be reduced to less than 10N (1 kg) for highly sensitive products and packaging. To avoid contamination of the vacuum holes, these are cleaned with air pressure after each application.

6 Label sizes

Labels with a width of 25 – 176 mm and a height of 25 – 200 mm can be applied.

7 Supporting air

is used for blowing the label to the pad.

8 Digital I/O Interface for applicator

A PLC, sensor or hand switch starts the labeling. At the same time, status and error messages are issued.

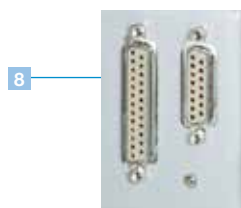

Inputs

Start
Print first label
External error
Stop (external error)
External reset only for 25 pin

Outputs

Printer not ready
Printer without job
Collective alarm
Home position reached
Labeling position reached
Labeling error

Applicator	A1000-220	A1000-300	A1000-400
Application	A2+, A4+, A6+	A2+, A4+, A6+	A2+, A4+, A6+
Cylinder stroke mm	220	300	400
Tamp stroke below device mm	70	150	250
Compressed air bar	4,5		

Accessories - Applicator A1000

9.4



Tamps

Labels are applied on the tamp and held by vacuum. The applicator then moves the tamp with label to the product.

Universal tamp pad

The rasterized vacuum holes are covered by a foil and are pierced according to the label size.

Tamp pads are manufactured according to the label size.

	Universal tamp pad			Tamp pad		
	A1021 / 70 x 60	A1021 / 90 x 90	A1021 / W x H	A2+	A4+	A6+
Application	A2+	A4+	A4+	A2+	A4+	A6+
Label width mm	25 - 63	25 - 70	25 - 90	25 - 63	25 - 116	50 - 176
Label height mm	25 - 60		25 - 90	25 - 200		
Product surface	flat					
Product height	variable					
Product during labeling	not moving					

9.5



Tamp spring-mounted

The spring deflection allows labeling even on inclined surfaces.

Universal tamp pad

The rasterized vacuum holes are covered by a foil and are pierced according to the label size.

Tamp pads are manufactured according to the label size.

	Universal tamp pad		Tamp pad	
	A1321 / 116 x 102	A1321 / 116 x 152	A1321 / W x H	
Application	A4+		A4+	A6+
Label width mm	25 - 116		25 - 116	50 - 176
Label height mm	25 - 102		25 - 200	
Product surface	flat			
Product height	variable			
Product during labeling	not moving			

9.6



Blow pad

The label can be blown on in case of pressure-sensitive products. The blow pad moves to a fixed height. The product to be printed is positioned about 10 mm below.

Blow pad	A2021		
Application	A2+	A4+	A6+
Label width mm	25 - 63	25 - 116	50 - 176
Label height mm	25 - 100		
Product surface	flat		
Product height	fixed		
Product during labeling	not moving or moving		

9.7

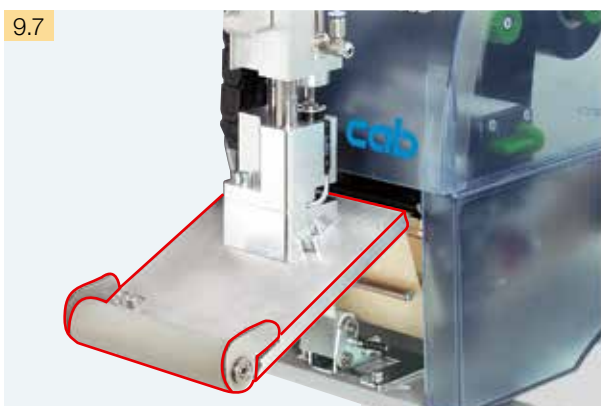

Roll-on pad

Using the roll-on pad the label is moved to below the roll. The pad moves onto the product and the label is rolled on during transport.

Roll-on pad	A1411	
Application	A4+	A6+
Label width mm	25 - 116	50 - 176
Label height mm	80 - 200	80 - 200
Product surface	flat	
Product height	variable	
Product during labeling	moving	

Applicator A3200

9.8

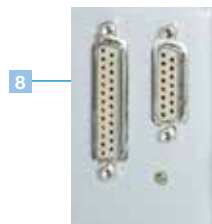
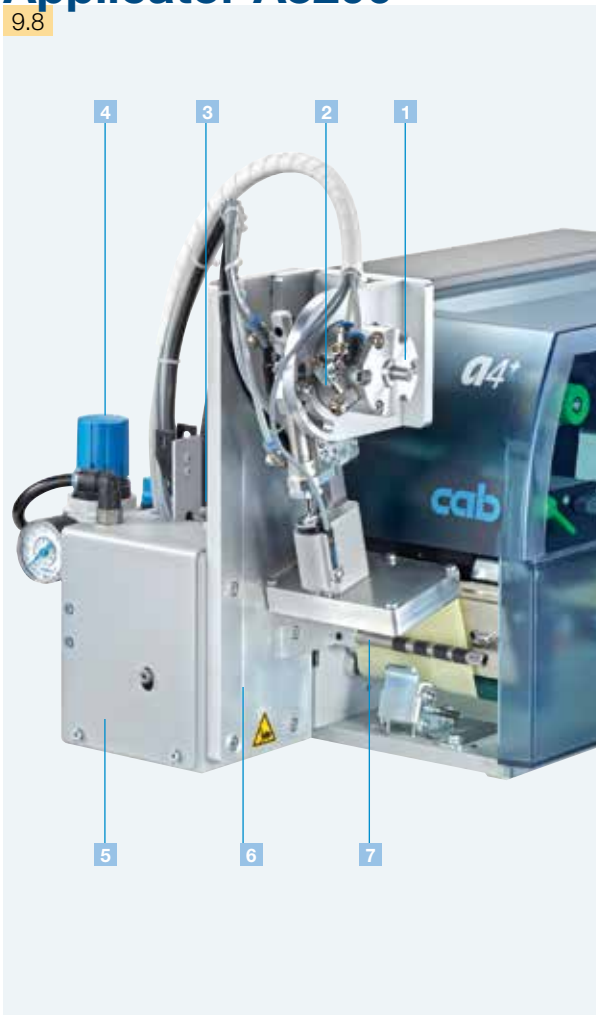

Applicator A3200 – Real time application

The A3200 applicator is used to automatically apply labels that are printed with the A2+ / A4+ printer.

A rotary cylinder allows positioning the label between 45° and 95° which is then placed on the product via short stroke cylinder.

1 Long service life

The ball-bearing guides are low-wearing.

2 Variable angular position

The rotary cylinder allows labeling on horizontal, inclined and vertical surfaces.

3 Pre-dispensing button

Pushing the button the first time causes the label to be printed and held by the pad. Pushing the button again starts the application.

4 Compressed air regulation unit

The microfilters prevent contamination, the compressed air regulator ensures the labeling quality.

5 High process reliability

The supporting air jet stream, induction air and lifting speed can be adjusted. The pressure can be reduced to less than 10N (1 kg) for highly sensitive products and packaging. To avoid contamination of the vacuum holes, these are cleaned with air pressure after each application.

6 Label sizes

Labels with a width of 4 – 116 mm and a height of 5 – 80 mm can be applied.

7 Supporting air

is used for blowing the label to the pad.

8 Digital I/O Interface for applicator

A PLC, sensor or hand switch starts the labeling. At the same time, status and error messages are issued.

Inputs

- Start
- Print first label
- External error
- Stop (external error)
- External reset only for 25 pin

Outputs

- Printer not ready
- Printer without job
- Collective alarm
- Home position reached
- Labeling position reached
- Labeling error

Applicator	A3200
Application	A2+ / A4+
Rotary cylinder°	45 - 95°
Lifting cylinder mm	up to 30
Compressed air bar	4,5

Tamp pads or other blow pads are manufactured according to the label size.

Application	Tamp pad A3221		Blow pad A3221	
	A2+	A4+	A2+	A4+
Label width mm	4 - 63	20 - 116	10 - 63	20 - 116
Label height mm	5 - 80		10 - 80	
Product surface	flat			
Product during labeling	not moving		in motion	

9.9

9.10

9.10



Accessories - mounting equipment

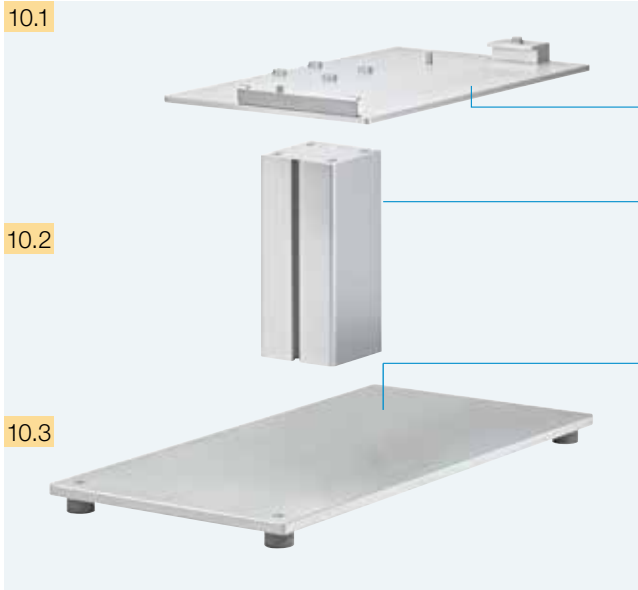

Mounting foot (for A2+, A4+)

For fastening the print and apply system and product holder.

1 Mounting plate

The print and apply system is fastened on the mounting plate.

2 Profile

Standard lengths are 40, 80, 120 mm.

The aluminum square profile can also be manufactured in other lengths upon request.

3 Base plate

For fastening the product holder

Standard size: 500 x 255 mm.



Floor stand

The floor stand enables the printer to be quickly and flexibly integrated into any manufacturing line. Height and width of the labeling position are easy to adjust. Four guide rollers at the chassis provide for mobility. The floor stand is adjusted with adjustable feet at the place of destination.

Floor stand	1600
Total height mm	1600
Labeling height up to mm	1400
Projection until middle of label mm	230 - 500
Chassis: Width x depth x height mm	600 x 860 x 140



Printer holder

The A2+, A4+ or A6+ label printers are fixed on the plate and quicklocked.

Label software cablabel® S3



The goal of cablabel® S3 is to concentrate the label design, print control and monitoring of all cab marking systems into one software package. The software will also be in sync with future developments of new devices and features.

Highlights

cablabel® S3 features the full potential of the cab devices like no other available software: the software utilizes the JScript code to the full extent. cablabel® S3 Pro can import existing JScript files, so you can switch over from R2+ seamlessly. With the new layer technology the user designs a label which works for all established devices and resolutions. The intelligent print control evaluates the device and label parameters to reduce possible sources of error.

cablabel® S3 also maximizes the integration of database connections via Database Connector. After designing the label, the software provides all files to be stored within the printer for database connections. The software also supports the stand-alone feature as well using the same method. In Addition the software creates interfaces which are easy to handle for the connection to SAP or other peripheral devices like SPC, scales and bar code testers.

Products

Every company designs and formats their label differently. For example, label creation and production are executed by different employees. To adopt the software package to your needs, cab offers different software packages.

cablabel® S3 Lite is offered free of costs with every cab printer and allows you to create and print labels. With cost-saving cablabel® S3 Pro you create label designs for technical solutions. cablabel® S3 Viewer shows the preview of a label in the Windows Explorer and is delivered free of costs with every cablabel® S3. The Viewer may support you for showing examples during the approval processes or supplier requirements.

cablabel® S3 Print is provided for users in production or warehouse. The user interface is simplified and makes only those functions available which are required for label printing: You select the label in a list and get the layout for visual control. Then you enter the variable information and the amount you want to print. This simplifies your work and reduces possible sources of error.

Other products like cablabel® S3 Pro Laser, Print Laser und Print Server are in preparation.

Integration



No printer is isolated – in a productive environment it is connected to other equipment or networks for control and monitoring. cab offers various possibilities to integrate the printer into your environment.

Control

Every cab printer can be directly coded with the simple programming language *JScript* and an extensive instruction set. The label software *cablabel*® S3 supports optimally *JScript*, but a *JScript* program may also be created with any text editor.

As an integrated element of the firmware, the *abc Basic compiler* enables the printer to process data via BASIC programming before it is sent for print editing. That way, you replace external printer languages or integrate data from other systems, e.g. balance or a PLC.

11.4 In the stand-alone mode with additional network connection, the *Database Connector* enables printers to access data directly from a central ODBC-, OLEDB compatible database and to print it as a label.

In cooperation with SAP cab developed the so-called *replace method* to control cab printers quickly and easily from SAPScript using SAP R/3. Using the replace method the host computer only sends the *JScript* variable, respectively changed data to the printer.

As a Silver Level partner in SAP's Printer Vendor Programm, cab has access to the SAP development environment for optimum printer support in SAP environments.

* SAP is a registered trademark of SAP AG.

11.10 The *Programmer's guide* explains and describes commands for different printer models via direct programming with *JScript* and *abc* and additionally the connection of the printer to databases via *Database Connector*.

For the printer control via PC drivers are available for established Windows operating systems, and for A+-printers CUPS-based drivers for Mac OS X and Linux. The drivers ensure optimal stability on your operating system.

Monitoring

Using standard programs such as the web browser or FTP clients, the integrated HTTP and FTP server enables print monitoring, configuration, firmware updates and memory card administration. Status, warning and error messages are sent to administrators or users as e-mails or SNMP datagrams via SNMP and SMTP clients. A time server is used to synchronize time and date.

11.6 The *Administration Network Manager* enables the user to control a number of printers across a network simultaneously. It supports monitoring, configuration, firmware updates, memory card administration, file synchronization and PIN administration centrally.

Stand-alone operation



Printing without PC

Stand-alone operation is the ability of cab printers to print labels even if these are not connected to the host system.

The label layout is designed with a special label software or direct programming via PC.

Label formats, fonts, font-, text- and graphics data as well as data base contents are saved or read on the CF memory card, USB stick or internal data memory IFFS.

Only variable data to be printed is sent to the printer via keyboard or host. Additionally, data sent by a barcode scanner or balance can be processed.

Easy maintenance



Label sensor

If cleaning might come up the label sensor is unlocked and pulled out with slight finger pressure.



Printhead

The printhead may be exchanged in just a few steps. And no need of doing adjustments and settings.



Print roller

Three screws allow an easy and fast removing of the print roller for cleaning or replacement.

No need for a service technician to perform routine maintenance.

One single tool

For replacing wear parts or mounting peripherals the tool is directly inserted in the printer and at the ready.





Service

Our well-trained service engineers give world-wide support in maintenance and repair of cab printers. Please send your printer to one of cab's service centres or to one of the service partners selected by us. We will check and repair your printer within only a few working days. If requested, we will make a temporary equivalent device available for the time of repair.



Training

We offer training in programming, different software tools, printer drivers and label layout design. We can enhance your knowledge on cab printers to make more effective use of our printers.

We also offer seminars for maintenance and repair.

Delivery program for label printers



		Art.-No.	Hardware	dpi	Art.-No.	Spare parts	Art.-No.	Spare parts				
1.1		5954511	Label printer A2+ /	300	5954105.001	Print head 2 / 300	5954102.001	Print roller DR2 Rew. Ass. roller RR2				
		5954512	Label printer A2+ /	300P								
		5954575	Label printer A2+ /	600	5958686.001	Print head 2 / 600						
		5954578	Label printer A2+ /	600P								
1.2		5954500	Label printer A4+ /	200	5954081.001	Print head 4 / 203	5954180.001	Print roller DR4 Rew. Ass. roller RR4				
		5954505	Label printer A4+ /	200P								
		5954501	Label printer A4+ /	300	5954072.001	Print head 4 / 300						
		5954506	Label printer A4+ /	300P								
1.2		5954502	Label printer A4+ /	600	5954077.001	Print head 4 / 600	5954180.001	Print roller DR4 Rew. Ass. roller RR4				
		5954507	Label printer A4+ /	600P								
		5954524	Label printer A4.3+ /	200	5954085.001	Print head 4.3 / 203						
		5954526	Label printer A4.3+ /	200P								
1.2		5954525	Label printer A4.3+ /	300	5954089.001	Print head 4.3 / 300	5954180.001	Print roller DR4 Rew. Ass. roller RR4				
		5954527	Label printer A4.3+ /	300P								
		1.3		5954587	Label printer A6+ /	200			5954217.001	Print head 6 / 203	5954245.001	Print roller DR6 Rew. Ass. roller RR6
				5954588	Label printer A6+ /	200P						
5954513	Label printer A6+ /			300	5954106.001	Print head 6 / 300						
5954514	Label printer A6+ /			300P								
1.4		5954517.101	Label printer A8+ / with metal cover	300	5954107.001	Print head 8 / 300	5954103.001	Print roller DR8				
1.5		5954552	Label printer A4+M /	300	5954072.001	Print head 4 / 300	5954180.001	Print roller DR4				
		5954554	Label printer A4+M /	600	5954077.001	Print head 4 / 600	5954183.001	Print roller DR4 Rew. Ass. roller RR4				
1.6		5959640	Label printer XD4 /	300	5954072.001	Print head 4 / 300	5954180.001	Print roller DR4				
1.7		5954568	Label printer A4+T /	300	5954072.001	Print head 4 / 300	5954180.001	Print roller DR4				
1.8		5959970	Label printer XD4T /	300	5954072.001	Print head 4 / 300	5954180.001	Print roller DR4				
1.9		5965700	Label printer XC4 /	300	5954072.001	Print head 4 / 300	5954180.001	Print roller DR4				
1.10		5965701	Label printer XC6 /	300	5954106.001	Print head 6 / 300	5954245.001	Print roller DR6				
		Art.-No.	Special printers		Scope of delivery: Label marker, Power cable Type E+F, Length 1,8 m Connecting cable USB, Length 1,8 m Operation manual Ge/En							
1.11		59545xx.101	Printer with metal cover for A4+ / A4+M / A4+T / or A6+		DVD: Operation manual in 21 different languages (only A+ series), Operation manual Ge/En/Fr, XD4 / XD4T Configuration manual Ge/En/Fr, Service manual Ge/En, Spare parts list Ge/En, Programmer's guide En, Windows printer driver 32 / 64 bit in 19 different languages for Windows XP Server 2003 Windows Vista Server 2008 Windows 7 Server 2008 R2 Windows 8 Server 2012 Windows 8.1 Server 2012 R2 Mac OS X driver Ge/En/Fr (only A+ series), Linux driver Ge/En/Fr (only A+ series), Label software cablabel S3 Lite Label software cablabel S3 Viewer							
1.12		595xxxx	Label printer for thermal direct printing on request									
		595xxxx (((RFID)))	Printer with RFID read-write unit 13,56 MHz									
					For current data please surf to www.cab.de							







Delivery program for accessories

	Art.-No.	Special equipment
2.1	5954012.001 5954013.001	Metal cover A4+ Metal cover A6+
2.2	5953700.001	Print roller DR4-M25
	5953701.001	Print roller DR4-M50
	5953702.001	Print roller DR4-M80
2.3	5958631	Reflective label sensor from top
2.4	5959622.001	Adapter 100
2.5	5561043	Memory card CompactFlash Type I
2.6	5901626	Standard keyboard USB German version
2.7	5954380	External operation panel
2.8	5946146	Pause adapter PS7
2.9	5571005 5571000	Barcode tester CC2
		Barcode tester CC4
	Art.-No.	Interfaces
3.1	5954200	Centronics Interface
3.2	5954201	RS422 / RS485 Interface
3.3	5954191	Label selection box - I / O box
3.4	5561041	WLAN Card 802.11 b / g
	Art.-No.	Connecting cables
4.1	5550818	Connecting cable RS232 C 9 / 9 pin, length 3 m
4.2	5918008	Patch cable KAT 5e, 3 m gray
	Art.-No.	Cutting, perforating, stacking
5.1	5948382 5948000 5948001 5948002	Cutter CU2
		Cutter CU4
		Cutter CU6
		Cutter CU8
5.2	5946995	Cutter tray 4
5.3	5960050.351 5960050.352	Perforation cutter PCU4 / 2,5
		Perforation cutter PCU4 / 10
5.4	5541311 5541313	Stacker with cutter ST4 / L
		Stacker with cutter ST4 / M
5.4	55xxxxx 55xxxxx	Storage table ST4 / L, label WxH Storage table ST4 / M, Label BxH
5.5	5958932	Base frame A4+

	Art.-No.	Rewinding, unwinding labels
6.1	5954108.001 5954190.001	Rewind guide plate RG2 for internal rewinding
		Rewind guide plate RG4 for internal rewinding
6.2	5948102 5943251 5945802	External rewinder ER1 / 210
		External rewinder ER2 / 210
		External rewinder ER3 / 210
6.3	5948100 5946090 5946420 5945804 5948170 5966077.001 5966078.001	External rewinder ER4 / 210
		External rewinder ER4 / 300
		External rewinder ER6 / 300
		External rewinder ER8 / 300
		Connection set for ER / EU
6.4	5966077.001 5966078.001 5946091 5946421 5945806 5948170	Rewind guide plate RG4 XC4
		Rewind guide plate RG6 XC6
		External unwinder EU4 / 300
		External unwinder EU6 / 300
		External unwinder EU8 / 300
	Art.-No.	Dispensing labels
	7.1	5946120
7.2	5958772 5948830 5958565	Extended peel-off plate A2+
		Extended peel-off plate A4+
7.3	5942353	Present sensor PS6 Manual / automatic operation
		Present sensor PS8 Manual operation
7.4	5946900	Present sensor PS9
7.5	5948595	Present sensor PS8 Manual operation
	Art.-No.	Accessories for dispensing labels
8.1	5942345	Hand switch TR1
8.2	5535901	Foot switch
8.3	5917652	Interface connector SUB-D plug 15 pin Phoenix Contact 2761606
8.4	5941526	Product sensor to start
8.5	5533240	Testbox 2 Automatic operation

Delivery program for accessories

	Art.-No.	Applicators and dispensing module
9.1	 5949281 5949265	Dispensing module A5104 Dispensing module A5106
9.2	 5941345	All-round print and apply system
9.3	 5949001 5949002 5949003	Applicator A1000-220 Applicator A1000-300 Applicator A1000-400
9.4	 5xxxxxx	Tamp pad A1021 W x H
	5949072	Universal tamp pad A1021 70 x 60
	5949075	Universal tamp pad A1021 90 x 90
9.5	 5xxxxxx	Tamp pad A1321 W x H
	5949076	Universal tamp pad A1321 116 x 102
	5949077	Universal tamp pad A1321 116 x 152
9.6	 5xxxxxx	Blow pad A2021 W x H
9.7	 5xxxxxx	Roll-on pad A1411 W x H
9.8	 5976050	Applicator A3200
9.9	 5xxxxxx	Tamp pad A3221 W x H
9.10	 5xxxxxx	Blow pad A3221 W x H

	Art.-No.	Accessories dispensing/applicators		
10.1	 5969811 5958367	Mounting plate A2+ Mounting plate A4+		
10.2	 5958365 5965929 5971136	Profile 40 Profile 80 Profile 120		
	on request 5xxxxxx	Profile L		
10.3	 5961203	Base plate 500 x 255		
10.4	 5947400	Floor stand 1600		
10.5	 8914422 8913693 8914423	Printer holder A2+ Printer holder A4+ Printer holder A6+		
	Art.-No.	Software		
	11.7	5588000	Label software cablabel® S3 Lite	
5588001		cablabel® S3 Pro 1 WS cablabel® S3 Pro 5 WS cablabel® S3 Pro 10 WS cablabel® S3 Pro 1 additional licence cablabel® S3 Pro 4 additional licences cablabel® S3 Pro 9 additional licences		
5588100				
5588101				
5588150				
5588151				
5588152				
11.7	 5588002 5588105 5588106 5588155 5588156 5588157	cablabel® S3 Print 1 WS cablabel® S3 Print 5 WS cablabel® S3 Print 10 WS cablabel® S3 Print 1 additional licence cablabel® S3 Print 4 additional licences cablabel® S3 Print 9 additional licences		
	from the 1st quarter 2015		cablabel® S3 Print Server	
	11.10		9008486	Programmer's guide, English printed copy

cab delivery program

Label printer EOS1
The compact for
label rolls up to 155 mm Ø



Label printer EOS4
The cost-effective for
label rolls up to 210 mm Ø



Label printer EOS mobile
Both EOS sizes with battery
pack for mobile print



Label printer A+ series
The universal



Label printer A+M
with centered material guide



Label printer XD4
double-sided printing



Textile printer A4+T
For textile material



Label printer XD4T
double-sided printing of
textile material



Label printer XC4
two-color printing



Label printer XC6
two-color printing



Label dispenser HS
Precise and easy dispensing in
horizontal direction
up to a width of 180 mm



Label dispenser VS
precise and easy dispensing in
vertical direction
up to a width of 180 mm



Print & apply system Hermes+
for automation



Print module PX series
for integration into automatic
labeling systems



Labels / Transfer ribbons
precise printing with cab's labels
and transfer ribbons



Label software cablabel® S3
standard and optional software



Laser marking system FL+ series
Precise and fast



Laser safety housing
The industrial solution



- Headquarters in Germany
- cab offices
820 partners
in over 80 countries

cab maintains a presence in the world's major economic areas.



For current data, please refer to www.cab.de

Germany

cab Produkttechnik
GmbH & Co KG
Postfach 1904
76007 Karlsruhe
Wilhelm-Schickard-Str. 14
76131 Karlsruhe
Telefon +49 721 6626-0
Telefax +49 721 6626-249
www.cab.de
info@cab.de

Further partners
on request

France

cab technologies s.a.r.l.
67350 Niedermodern
Téléphone +33 388 722 501
www.cab.de/fr
info.fr@cab.de

USA

cab Technology Inc.
Tyngsboro MA, 01879
Phone +1 978 649 0293
www.cab.de/us
info.us@cab.de

South Africa

cab Technology (Pty.) Ltd.
2125 Randburg
Phone +27 11-886-3580
www.cab.de/za
info.za@cab.de

Asia 亚洲

cab Technology Co, Ltd.
希爱比科技股份有限公司
Junghe, Taipei, Taiwan
Phone +886 2 8227 3966
www.cab.de/tw
info.asia@cab.de

China 中国

cab (Shanghai) Trading Co., Ltd
铠博(上海)贸易有限公司
Phone +86 21 6236-3161
www.cab.de/cn
info.cn@cab.de

This documentation and any translations hereof are the property of cab GmbH & Co KG.

The replication, processing, reproduction or distribution in whole or in parts requires our prior written consent. © Copyright by cab/9008476.

All delivery, design and technical specifications are compiled to the best of our current knowledge and are subject to change without prior notice.